



Digital Temperature Controller

CONOTEC CO., LTD.

www.conotec.co.kr



-FOX-2001
-FOX-2001S

Model	Sensor	Output	Temp. range	Function
FOX-2001	NTC	Relay	-55.0°C ~ +99.9°C	temp. control
FOX-2001S	NTC	SSR	-55.0°C ~ +99.9°C	temp. control

※ Thank you for selecting our products. Please read carefully this instruction to reduce any damages or operation mistakes.

■ Part name

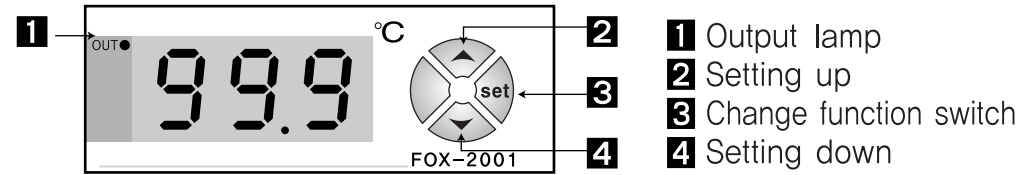

■ The function of each key.

1. : A key to change of the programs & setting temperature
2. : A key to change of the program's set values & temperature.

■ Detailed manual

1. **HSP** : Setting function of the highest limit of temperature range (Maximum set point allowed to the end user)
-Impossible to set up the set value more than **HSP** set value
ex) **HSP** = 25.0°C setting → impossible to raise the set value more than 25°C
2. **LSP** : Setting function of the lowest limit of temperature range (Minimum set point allowed to the end user)
-Impossible to set up the set value less than **LSP** set value
ex) **LSP** = 10.0°C setting → impossible to lower the set value less than 10.0°C
3. **tYP** : Selection of the Cooling(CoL) & Heating(HEt)
4. **dIF** : Selection of deviation

P : + deviation (in the set point > off)

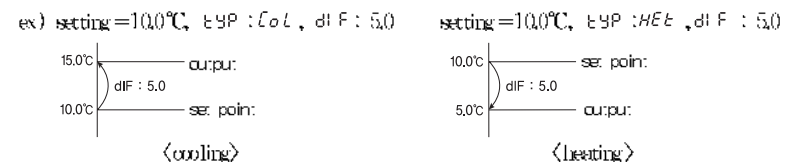

Pn : ± deviation

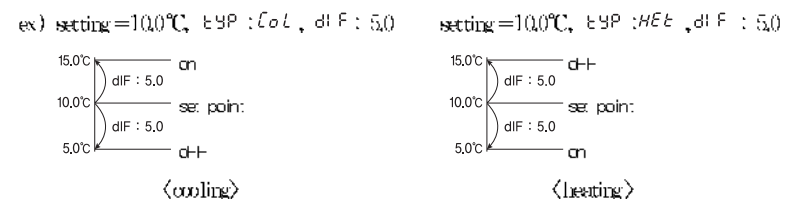

5. **dIF** : Setting for temperature deviation

- In the ON/OFF control, it needs at regular interval between ON and OFF.
- By operating the ON/OFF control frequently, the relay or its output contact can be damaged quickly and it also occurs the hunting(oscillating, chattering) by virtue of external noise. You can make use of the temperature deviation in order to protect its relay or contact and so on.

「 ex ⇒ The method of the temp. deviation when ON/OFF control 」

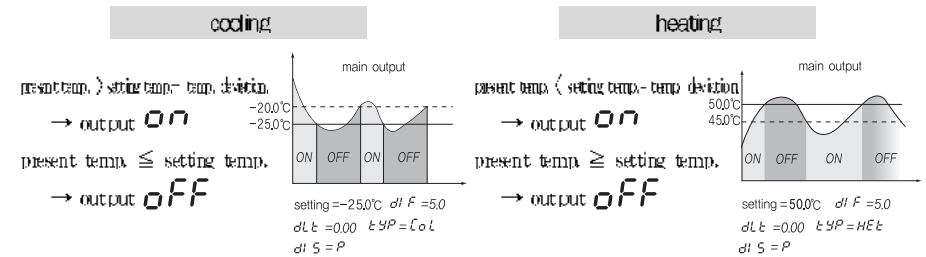

6. **dLt** : Delay time of the output

It is widely used as the followings

- in case of operating the ON/OFF control very often,
- to protect the operation machinery when re-input of the power supply or momentary stoppage of power supply

ex) If the set value is 1.30 :

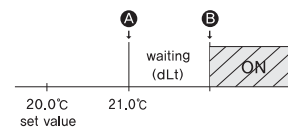

from (A) until (B) time → the relay is ON in the (B) point after as delay as the **dLt** setting time (1min30sec) (flickering the Output lamp during the **dLt** time)

7. **Cor** : Correction of the present temperature

It is used for the correction of an discrepancy between the display temperature and real temperature.

ex) real temp. : 10.0°C → **Cor** : 0.0 ⇒ -2.0 correction → 10.0°C display
display : 12.0°C

8. **LoL** : The lock function

- As a safety device, it is used in order not to change the set values except for the main user.

ON- setting for the lock function.

OFF- removal for the lock function

Setting temperature

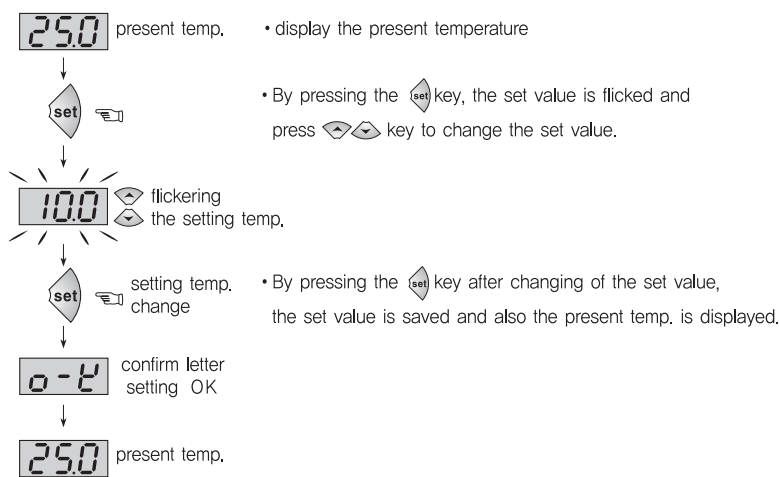

Setting for programs

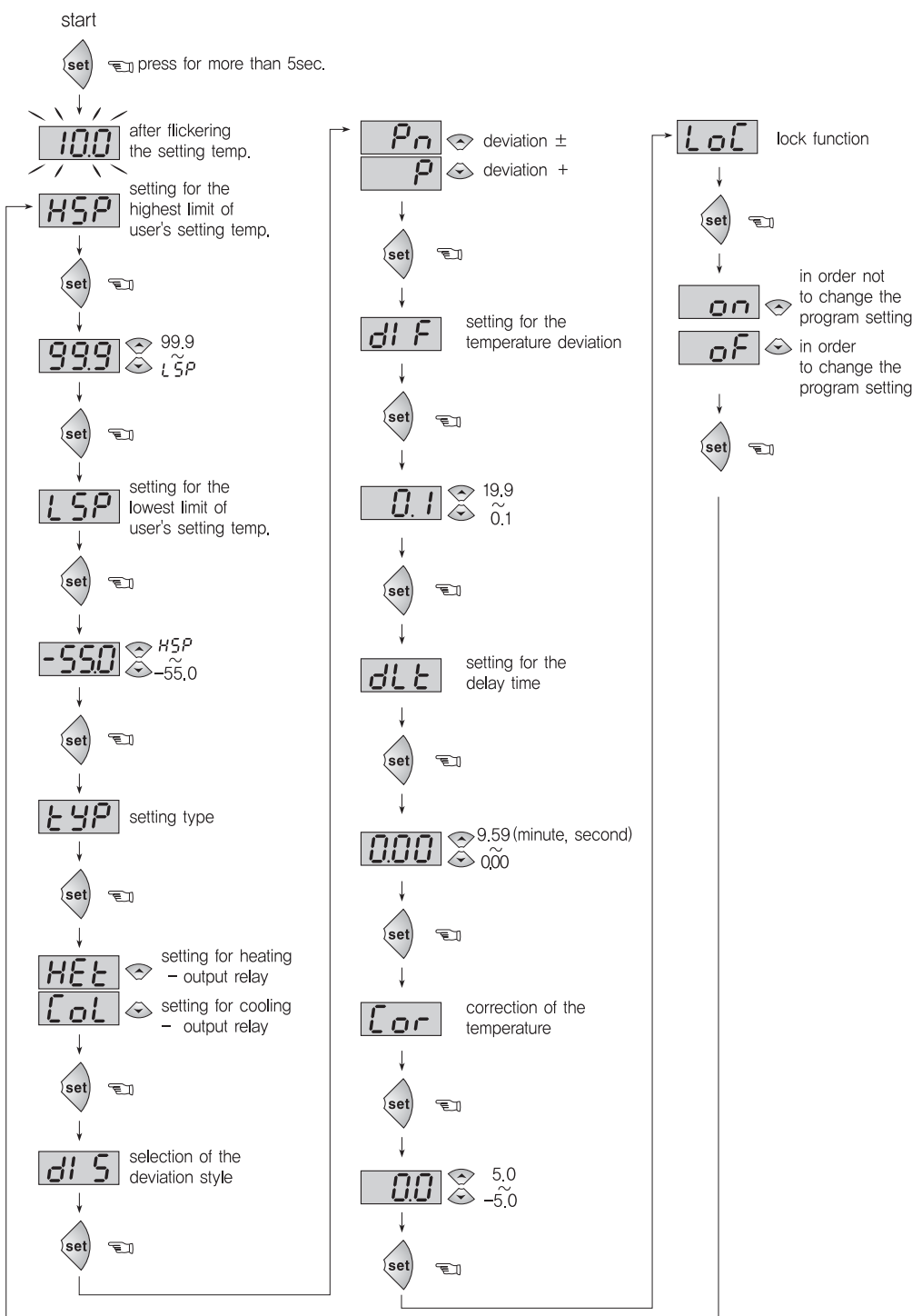

※ To change it with program mode press the key for more than 5 second in the present temperature display mode.
※ The set or programming mode is terminated, if you press the key for 2 second, parameters(set values) are saved after the display shows OK Hlt or return to present temperature automatically after 30 second.

Temp. range & set value when deliver

Function	Display	Range	Set values when deliver	Remarks	
Setting temp.	Temp. setting	-55.0~99.9	10.0		
Program	Setting for the highest limit of user	HSP	LSP~99.9	99.9	It is irrelevant to the relay output.
	Setting for the lowest limit of user	LSP	-55.0~HSP	-55.0	It is irrelevant to the output relay.
Setting	Selection of the function	tYP	CoL/HEt	CoL	HEt - heating CoL - cooling
	Selection of the deviation style	dIF	P/Pn	P	Pn - deviation± P - deviation+
	Temperature deviation	dIF	0.1~19.9	1.0	
	Delay time	dLt	0.00~9.59	0.00	(minute, second)
	Correction of temp.	Cor	-5.0~5.0	0.0	correct for an discrepancy between the display temp. and real temp.
	Lock function	LoC	on/of	of	on - setting for the lock function removal of the lock function however except for the setting temperature value. of -

ex) SSR junction

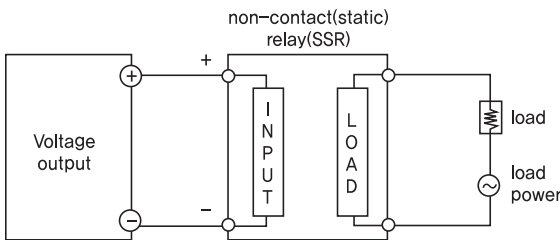

* Please make sure that the SSR's capacity should be used more than load capacity.

ex) Relay junction

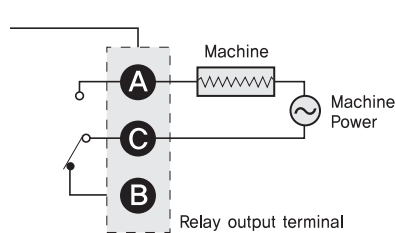

Connection

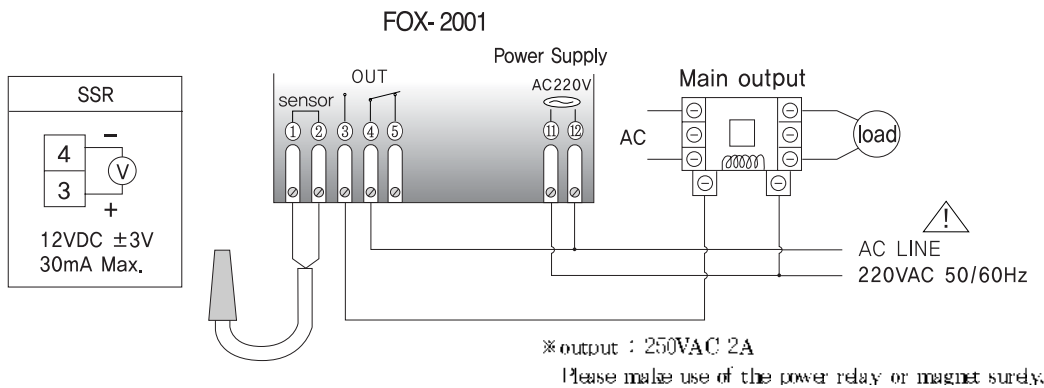

Dimension

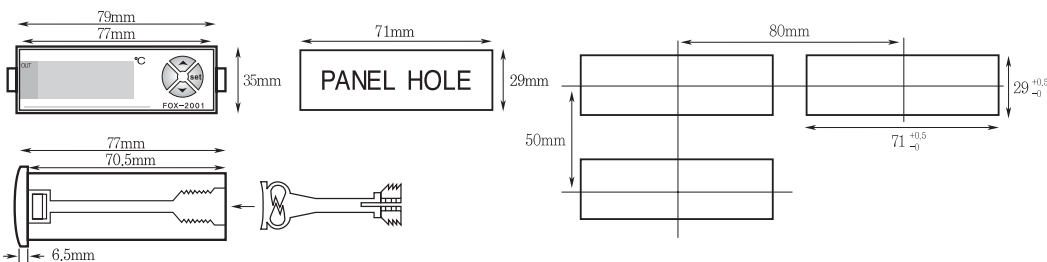

Safety and Hazard Instructions

Safety

Pls use this item after installing the duplex safety device in which is applied at dangerous factors such as serious human injury or serious damages of property & important machine because this item is not designed as safety device

Safety Instruction and Hazard Warnings

- Please read the operating manual through completely before putting the device into operation.
- We will not assume any responsibility for damage to assets or persons caused by improper handling or failure to observe the safety instructions or hazard warnings.
- For safety and licensing reasons, unauthorized conversion and/or modification of the device is not permitted.
- Do not exceed the maximum permissible current - in case of higher loads, use a contactor of adequate power. Make sure that the supplied voltage matches the values specified for the instrument.
- The device must be adequately protected from water and dust as per the application and must be accessible via the use of appropriate tools
- The device must not be exposed to extreme temperature, sunlight, strong vibrations or high levels of humidity.
- Operation or installation is not permitted under unfavorable ambient conditions such as wetness or excessive induction loads or solenoid and dust, combustible gases, vapors or solvents, especially high-frequency noise
- Avoid operation or installation close to high-frequency fields such as welding devices, sewing machines, wireless transmitter, radio systems, SCR controller, etc
- Do not install the sensor cable nearby signal cable, power cable, load cable
- Please use the shield cable when the sensor cable's lengthen, however do not make it too much longer
- Please use the sensor cable without any cutting or flaw, blemish.
- The device is not a toy and should be kept away from children
- Installation work must only be carried out by suitably qualified personnel who are familiar with the hazards involved and with the relevant regulations.
- You shouldn't tinker with anything or the product may not be opened or disassembled unless you know what you're doing. Please ask us about this questioning

Danger

Attention ! Never work on electrical connections when the machine is switched on

Error message

- E - I Memory error. Turn the power off and turn it on again
If the error message persists, please request us A/S by return
- o - E Sensor error. The sensor is interrupted. Check the cable.
- S - E Sensor error. The sensor is short-circuited. Check the cable

The terms of guarantee : for one year from the date of purchase

Model & output spec

	2001 (sensor : 1EA)	2001D (sensor : 1EA)	2001T (sensor : 1EA)	2001F (sensor : 1EA)	2000TT (sensor : 1EA)
temp. output	one-stage output	two-stage output	three-stage output	four-stage output	control by the temperature & time (for greenhouses)

	2001 (sensor : 1EA)	2002 (sensor : 1EA)	2003, 2003S (sensor : 1EA)	2004 (sensor : 2EA)	2005 (sensor : 2EA)	2006 (sensor : 2EA)	
temp. output	○	○	○	○	○	temp. 1	temp. 2
alarm output	-	○	-	-	○	alarm 1	alarm 2
defrost output	-	-	○	○	○	-	-
FAN output	-	-	○	○	○	-	-

ex) application

- ex) Heater → turn off at 30.0°C, turn on at 25.0°C
→ How to operate(setting for the temperature & programs)?

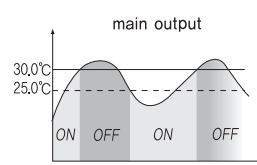

< setting temp. > (see the setting temperature)
setting : 30.0°C
< setting program > (see the setting for program)
tYP : HEt
dIF : P (deviation → one side, set point → off)
dLF : 5.0 (on/off interval → 5.0)

- ex) Cooler → turn off at 2.0°C, turn on at 0.0°C
→ How to operate(setting for the temperature & programs)?

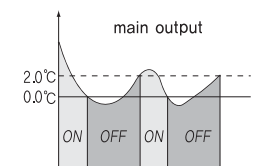

< setting temp. > (see the setting temperature)
setting : 0.0°C
< setting program > (see the setting for program)
tYP : CoL
dIF : P (deviation → one side, set point → off)
dLF : 2.0 (on/off interval → 2.0)

* The products specification can be changed without any notification to improve its quality.

H. Office : 56, Ballyongsandan 1-ro, Jangan-eup, Gijang, Busan, Republic of Korea
Factory : 56, Ballyongsandan 1-ro, Jangan-eup, Gijang, Busan, Republic of Korea

*This device works proper operation with:
Surrounding Temp. : 0°C~60°C
Surrounding Humi. : below 80%RH
Regular power : 220VAC±10% 50/60Hz

A/S TEL : +82-51-819-0425~7
FAX : +82-51-819-4562
E-mail : conotec@conotec.co.kr
Homepage : http://www.conotec.co.kr

MEMO