



CONOTEC CO., LTD.  
DIGITAL TEMPERATURE CONTROLLER



FOX-2003 Instruction Manual



- A user manual for this product is posted on the company website.
- Please download the technical document and communications manual on the company website.

01 Safety precautions

Please read the safety precautions carefully for correct operation of the product.

- ✱ The specifications and dimensions specified in this instruction manual may be changed without any notice for performance enhancement.

⚠ Warning

1. This product was not made as a safe device. Therefore, this product should be attached with dual safety devices if it is used for the control purposes (e.g. a device vulnerable to accident and property damage, etc.).
2. Do not wire, inspect or service this product while the power is being supplied.
3. You must attach this product to a panel. Otherwise, it may cause an electric shock.
4. When connecting the power, you must check the terminal number.
5. Do not ever disassemble, process, modify or repair this product.

⚠ Caution

1. Please make yourself familiar with all the operation instructions, safety precautions and warnings before using this product. Comply with related specifications and capacity requirements
2. Do not wire or install this product to any unit with high inductive load (e.g. motor, solenoid, etc.).
3. Use a shielded cable with a proper length when extending a sensor.
4. Do not use any part that generates an arc when used in the same power or directly switched in close proximity.
5. Keep the power cable away from a high-voltage cable and do not install this product in any place that is full of water, oil and dust.
6. Do not install this product in any place that is exposed to direct sunlight or rain.
7. Do not install this product in any place that is subject to strong magnetic power, noise, vibration or shock.

8. Keep this product away from any place that generates strong alkaline or acid substances. Use a separate pipe.
9. Do not sprinkle water onto this product for cleaning when installing it in the kitchen.
10. Do not install this product in any place where the temperature/humidity ratings are exceeded
11. The sensor cable should not be cut or cracked..
12. Keep the sensor cable away from a signal cable, a power cable or a load cable. Use a separate pipe.
13. Keep in mind that the follow-up service will not be available if this product has been arbitrarily disassembled and modified
14. ⚠ symbol on the terminal wiring diagram indicates a safety statement that alerts a warning or caution.
15. Do not use this product near any device generating strong high-frequency noise (e.g. high-frequency welding machine, high-frequency sewing machine, high-frequency radio, large-capacity SCR controller, etc.).
16. Using this product in any method other than those specified by the manufacturer may lead an injury or a property damage
17. The product is not a toy. Keep it away from children.
18. The product should be installed only by an expert or a qualified person.
19. The company will not be liable for any damage caused by the violation of the above warnings and cautions or by a consumer's fault

⚠ Danger

- Caution: Risk of electric shock
- Electric shock – Do not touch the AC terminal while the current is flowing. It may cause an electric shock.
  - Disconnect the input power before checking the input power.

02 Model Types

Model	Sensor	Control Method	Temperature Range	Function
FOX-2003 (For Freezing Only)	NTC	Relay Contact (3EA)	-55.0°C ~ 99.9°C	COMP Control DEF Control FAN Control

03 Components



- 1 COMP OUTPUT 2 DEF OUTPUT 3 FAN OUTPUT 4 DEF SWITCH  
5 UP SWITCH 6 Function SELECTOR SWITCH 7 DOWN SWITCH

Control Key Function

- set : Setting temperature
- Temperature and Program Configuration
- Manual Defrost Key Press and hold for more than 3 seconds to activate or deactivate the manual defrost function

04 Terminal wiring diagram

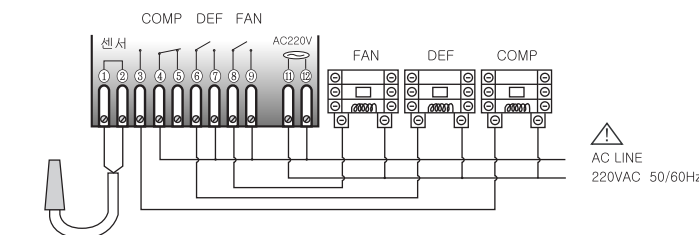

\* Output specification: When using 250VAC 2A or higher, always use a power relay or magnet

Relay Connection

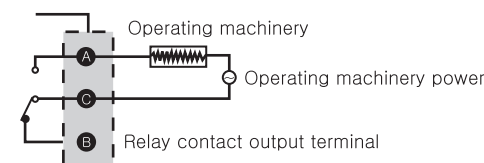

05 Setting process

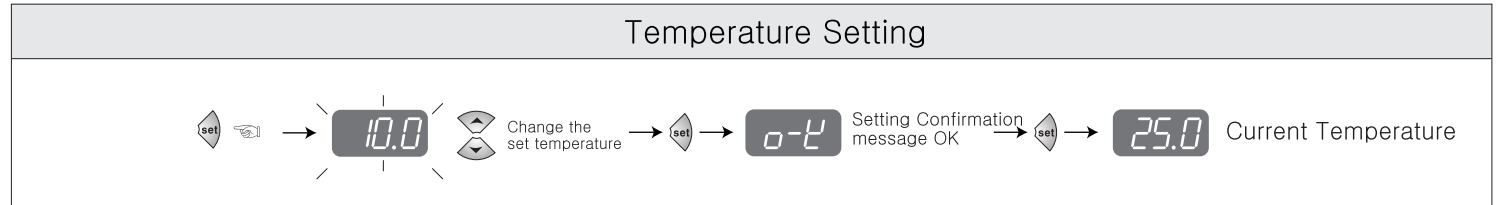

Program Setting (The Value of each item is the factory setting.)

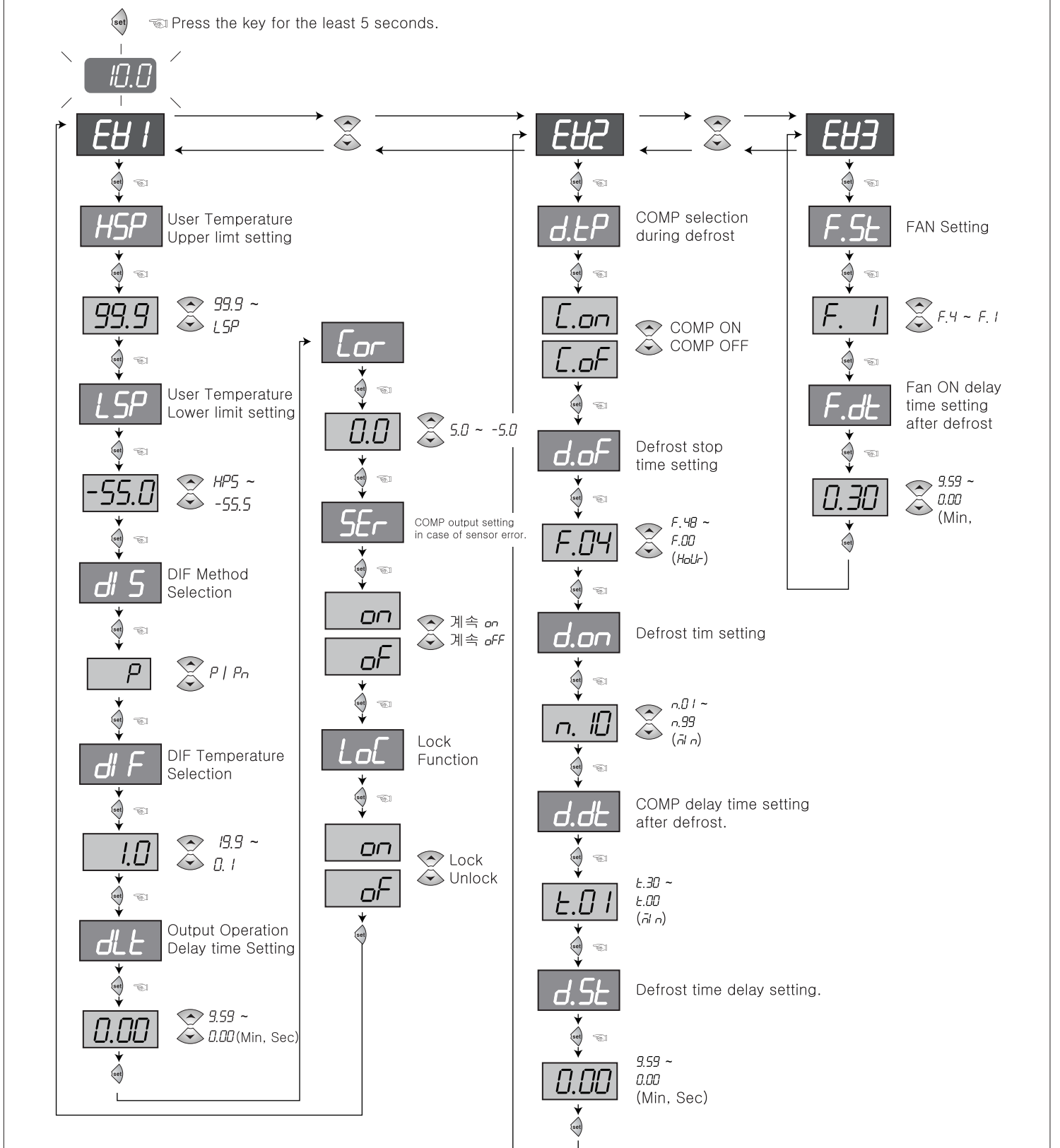

\* When the current temperature is displayed, press and hold the set key for 5 seconds to switch to program setting mode  
\* After finishing the settings for all programs, press and hold the set key for 2 seconds to confirm with an OK message and exit, or it will automatically return to the current temperature after 30 seconds

## 06 Function details

**E.H.1** : To change the set values for the temperature output.

**E.H.2** : To change the set values for the defrost output.

**E.H.3** : To change the set values for the FAN output

**HSP** : Setting function of the highest limit of temperature range  
Impossible to set up the set value more than **HSP** set value  
ex) **HSP** = 25.0°C Setting => Set temperature can be adjusted up to 25.0°C

**LSP** : Setting function of the lowest limit of temperature range  
Impossible to set up the set value less than **LSP** set value  
ex) **LSP** = 10.0°C Setting => Set temperature can be adjusted up to 10.0°C

**d.F.5** : Selection of the temperature deviation

**P** Output Operation: Set deviation to positive action (off at setpoint).

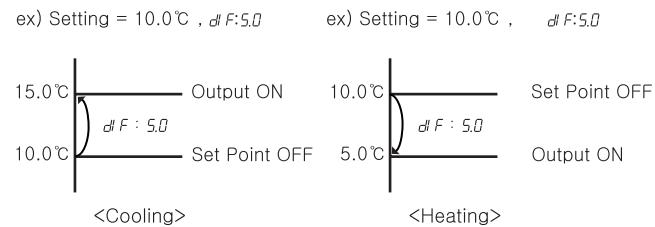

**Pn** Output Operation: Set deviation to ± action (based on the setpoint).

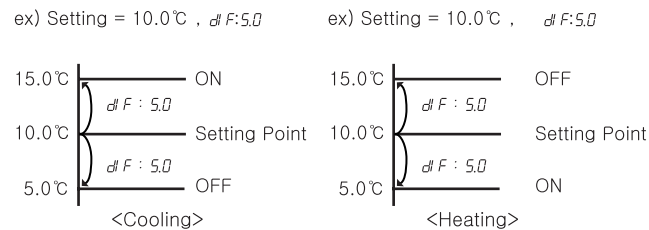

**d.F** : Setting for temperature deviation

- In the ON/OFF control, it needs a regular interval between ON and OFF  
- By operating the ON/OFF control frequently, the relay or its output contact can be damaged quickly and it also occurs the hunting (oscillating, chattering) by virtue of external noise. You can make use of the temperature deviation in order to protect its relay or contact and so on.  
- To prevent this phenomenon, a deviation temperature is set to protect the device's contacts and extend its lifespan.

• Present temp. > Setting temp. + Temperature deviation  
→ Output **on**

• Present temp. ≤ Setting temp.  
→ Output **off**

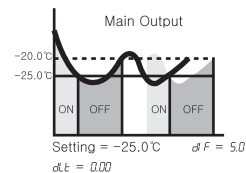

**d.Lt** : Delay time of the output

- Used when the control target frequently repeats ON/OFF operations, causing issues (e.g., refrigeration units, compressors, etc.).  
- To protect the operation machinery when re-input of the power supply or momentary stoppage of power supply

ex) If the set value is 1.30, from **A** until **B** time → the relay is ON in the point after as delay as the setting time (min. 30sec) (flickering the output lamp during **d.Lt** the time

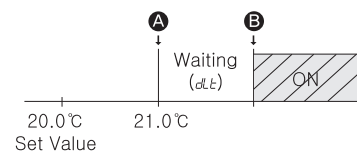

**Cor** : Correction of the present temperature  
This function calibrates when there is no issue with the product itself, but discrepancies occur due to errors in the input sensor or when the temperature differs from the reference temperature (e.g., mercury thermometer or existing thermometer/temperature controller).

ex) Preset temperature : 10.0°C → **Cor** : 0.0 → -2.0 Correction → 10.0°C Display  
Display : 12.0°C

**SEr** : COMP output setting when sensor error occurs (**0-E**, **5-E**)  
- **on** : continuous **on**, **off** : continuous **off**

**LoL** : The Lock function  
- As a safety device, it is used in order not to change the set values except for the main user.  
- **on** setting : Lock all settings except the set temperature value  
- **off** setting : Unlock all settings.

**d.t.P** : COMP selection during defrost.  
- **Com** : Defrosting : COMP ON  
- **CoF** : Defrosting : COMP OFF

**d.o.F** : Defrost stop time setting (defrost cycle).  
- Setting Range **F.00** ~ **F.48** hour  
- When the defrost cycle is reached, defrosting will occur.

**d.on** : Defrosting time  
- Setting Range **n.01** ~ **n.99** min  
- Operate the defrost while defrosting time.  
ex) **d.o.F** : **F.04** (4 hours), **d.on** : **n.10** (10 minutes) setting

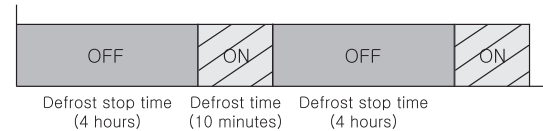

\* Repeat the defrost operation for 10 minutes every 4 hours

**d.dt** : Delay time of the COMP after defrost  
- Setting Range **t.00** ~ **t.30** min  
- Comp output is **on** : after as delay as the setting time after closing of the defrost

ex) **d.dt** : **t.01** (1 minute)

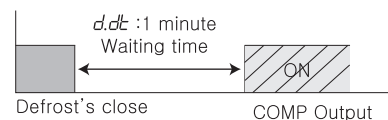

**d.St** : The delay time for defrost start  
- Setting range **0.00** ~ **9.99** (Minute, Second)  
- Comp output is **on** : After as delay as the setting time before operating of the defrost.  
ex) **d.St** : **0.10** Setting

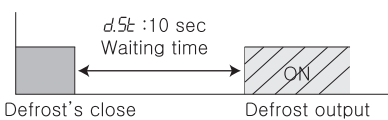

**F.5t** FAN setting (**F.1** ~ **F.4**)

Fan Setting	Comp ON	Comp OFF	Defrost ON
<b>F.1</b>	Fan ON	Fan OFF	
<b>F.2</b>	Fan ON		
<b>F.3</b>	Fan ON	Fan OFF	Fan ON
<b>F.4</b>	Fan ON		

\* Manual Defrost Setting Method

- Manual Defrost ON: Press **⏻** for more than 3 seconds, and the K2 LED will light up, starting the manual defrost. The display will alternate between **n.on** and the remaining defrost time.
- Manual Defrost OFF: While manual defrost is ON, press **⏻** for 3 seconds again to turn it off. Alternatively, it will automatically turn off after the **d.on** time.

**F.dt** : Delay time of FAN ON after defrosting  
- Setting range 0.00 ~ 9.59 (minute, second)  
- ex) **F.dt** : 0.30(30seconds)

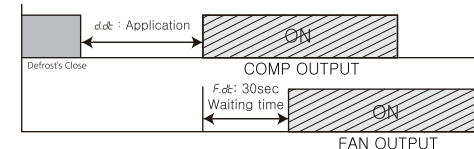

## 07. Model and Output Specifications

	2001 (Sensor : 1EA)	2001D (Sensor : 1EA)	2001T (Sensor : 1EA)	2001F (Sensor : 1EA)	2000TT (Sensor : 1EA)
Temp. Output	One-stage output	Two-stage output	Three stage output	Four-stage output	Control by the temperature & time (Specialized greenhouse)
Temp. Output	○	○	○	○	Temp 1 ○ Temp 2 ○
Alarm Output	-	○	-	-	Alarm 1 ○ Alarm 2 ○
Defrost Output	-	-	○	○	-
Fan Output	-	-	○	○	○

### Examples of Temperature Controller Usage.

The cooling unit turns off at 0.0°C and restarts at 5.0°C. Every 4 hours, the defrost output operates for 10 minutes. The fan turns ON when the COMP output is active, and turns OFF when the COMP is OFF or during defrost.

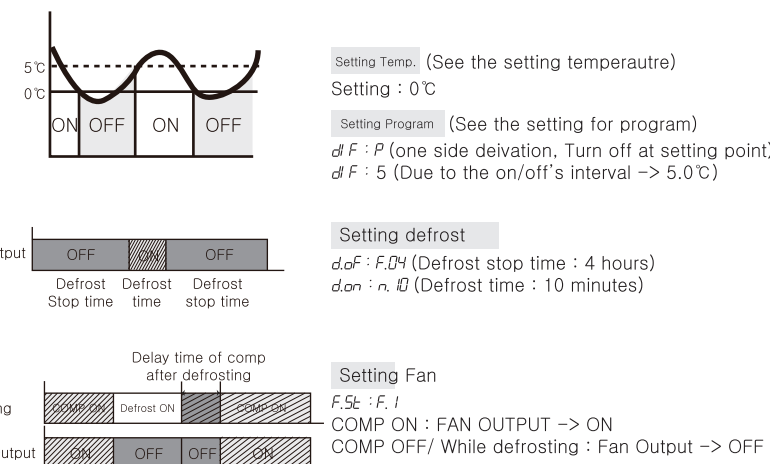

## 08 Dimension and panel hole sizes

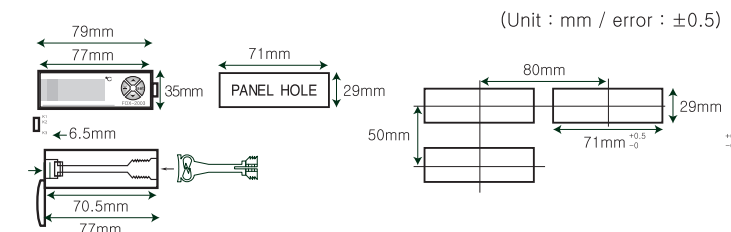

## 09 Easy error diagnosis instructions

\* If an error is displayed while the product is running

- **E.r.1** : It is case where the product was subject to a strong external noise and internal data memories have been damaged. In this case, contact us for product service.
- Although this controller was designed to withstand a certain level of external noise, it is not supposed to withstand all levels of noise.
- If the product is subject to a noise greater than 2KV, it could be internally damaged.
- If **0-E** (open error) or **5-E** (short error) is displayed, there is something wrong with a sensor. Please check the sensor.
- If **0-L** (OK) is displayed, settings have been saved.
- A text such as **LoLb** (lock) indicates that the product is in the lock mode.
- If **E.d.20** (product name) is displayed, it refers to a model name.

\* The above specifications may be changed without any notice for performance enhancement. Please make yourself fully familiar with and follow the above precautions.

- Warranty period: One year from the date of purchase
- Address : (Street address) 56, Ballyongsandan 1-rp, Jangan-eup, Gijang-gun, Busan, ROK  
(Land-lot address) 901-1, Ballyong-ri, Jangan-eup, Gijang-gun, Busan, ROK (46034)

- Product service : 070-7815-8289
- Customer service : 051-819-0425 ~ 0427
- FAX : 051-819-4562
- Email : conotec@conotec.co.kr
- SNS : Facebook, Instagram, Twitter, YouTube ▶ 'Search for 'Conotec'
- Website : www.conotec.co.kr

### Installation precautions

- This device should be connected to a protective earth terminal and a power supply in order to prevent an electric shock.
- Do not block the air outlet.

### Operation precautions

- \* An operating environment of this device is as follows.
- Ambient temperature : 0 ~ 60°C
- Ambient humidity : 80%RH or less
- Indoor uses only
- Pollution class 2
- Altitude under 2000m
- Installation category : II
- This device should be laid out in a way that its power cord is easy to handle.
- Using this product in any method other than those specified by the manufacturer may damage its protection function

### Major products and development

- Temperature/humidity controller
- Counter and timer controller
- Current and voltage panel meter
- Temperature/humidity indicator
- Oven controller
- CO2 controller
- PID controller
- Unit cooler controller
- Heat pump controller
- Chiller controller
- Thermo-hygrostat controller
- Short message alarm
- Temperature/humidity transmitter
- Smartphone app and monitoring system

\* This manual was prepared in the Naver Nanum fonts.