



Thank you very much for selecting our products.

#### 1 Caution for your safety

Please read this instruction carefully before using this controller  
 ※ The manual's information & specification can be changed to improve its quality without any notification.

#### ⚠ Safety

1. PIs use this item after installing the duplex safety device in which is applied at dangerous factors such as serious human injury or serious damages of property & important machine because this item is not designed as a safety device.
2. Do not check or repair when it is power on.
3. Please check the terminal number before connecting power supply.
4. Do not disassemble or open, remodel, repair without any permission.

#### ⚠ Safety Instruction and Hazard Warnings

- Please read the operating manual through completely before putting the device into operation.
- We will not assume any responsibility for damage to assets or persons caused by improper handling or failure to observe the safety instructions or haz and warnings.
- For safety and licensing reasons, unauthorized conversion and/or modification of the device is not permitted.
- Do not exceed the maximum permissible current - in case of higher loads, use a contractor of adequate power. Make sure that the supplied voltage matches the values specified for the instrument.
- The device must be adequately protected from water and dust as per the application and must be accessible via the use of appropriate tools
- The device must not be exposed to extreme temperature, sunlight, strong vibrations or high levels of humidity.
- Operation or installation is not permitted under unfavorable ambient conditions such as wetness or excessive induction loads or solenoid and dust, combustible gases, vapors or solvents, especially high-frequency noise
- Avoid operation or installation close to high-frequency fields such as welding devices, sewing machines, wireless transmitter, radio systems, SCR controller, etc
- Do not install the sensor cable nearby signal cable, power cable, bad cable
- Please use the shield cable when the sensor cable's lengthen, however do not make it too much longer
- Please use the sensor cable without any cutting or flaw, klemish.
- The device is not a toy and should be kept away from children
- Installation work must only be carried out by suitably qualified personnel who are familiar with the hazards involved and with the relevant regulations
- You shouldn't tinker with anything or the product may not be opened or disassembled unless you know what you're doing. Please ask us about this questioning

#### ⚠ Danger

Attention ! Never work on electrical connections when the machine is switched on

## 2 Composition

model	sensor	temp./hum. range	external size	function
FOX-302R1			W72 X H72mm	
FOX-9302R1	FS-200N HCPV-220H	-50.0~99.9°C 10 ~ 95%	W96 X H48mm	temp. control humid. control RS485 com.
FOX-8302R1			W94 X H150mm	

## 3 Part name

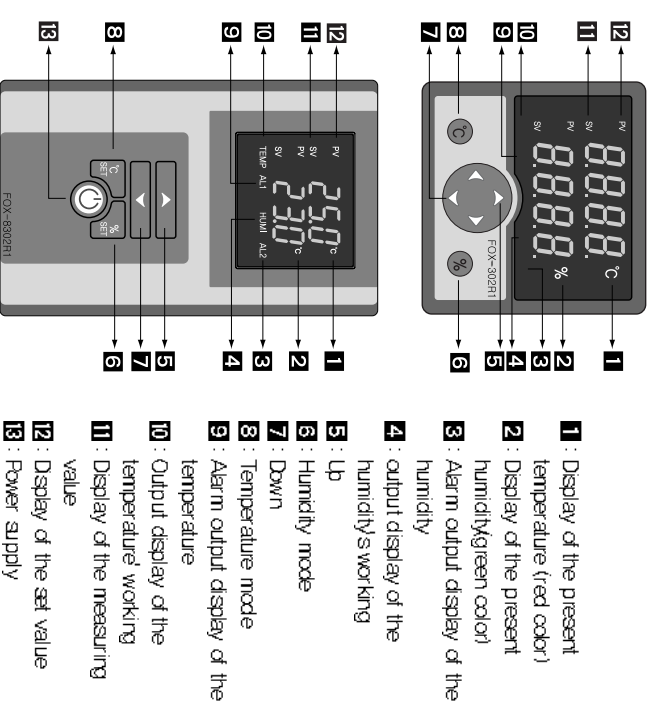

- 1: Display of the present temperature (red color)
- 2: Display of the present humidity(green color)
- 3: Alarm output display of the humidity
- 4: output display of the humidity's working
- 5: Up
- 6: Humidity mode
- 7: Down
- 8: Temperature mode
- 9: Alarm output display of the temperature
- 10: Output display of the temperature's working
- 11: Display of the measuring value
- 12: Display of the set value
- 13: Power supply

## 4 Connection

output : 250VAC 2A

Please make use of the power relay or a suitable magnet switch.

#### ▶ FOX - 302R1

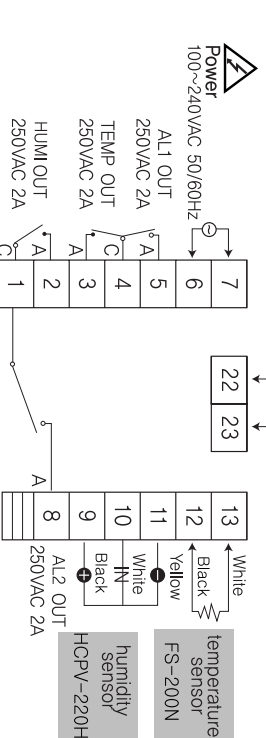

#### ▶ FOX - 9302R1

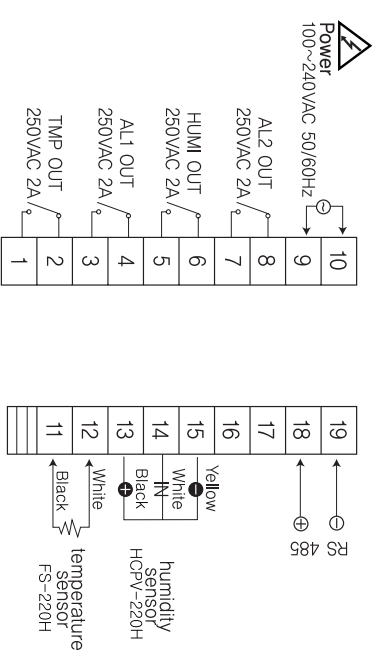

#### ▶ FOX-8302R1

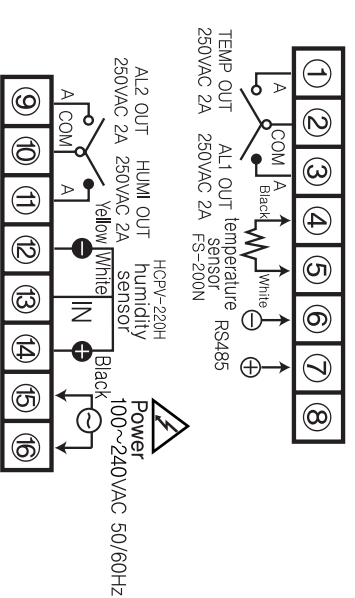

## 5 Size & Dimension

#### ▶ FOX-302R1(72x72x110mm)

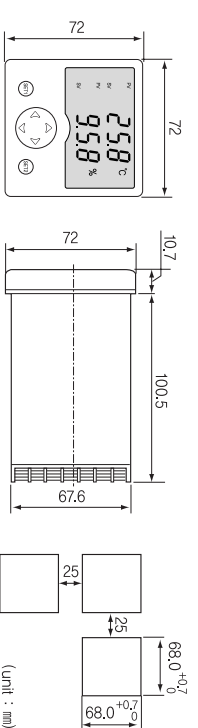

#### ▶ FOX-9302R1(96x48x110mm)

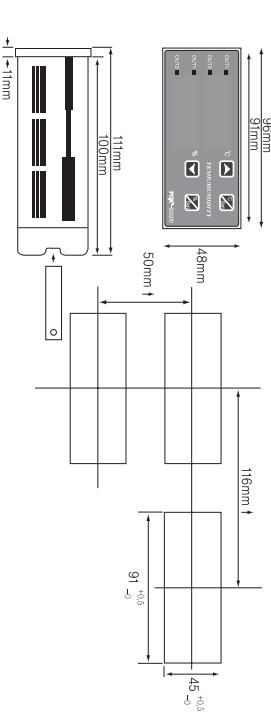

#### ▶ FOX-8302R1(94x150x39mm)

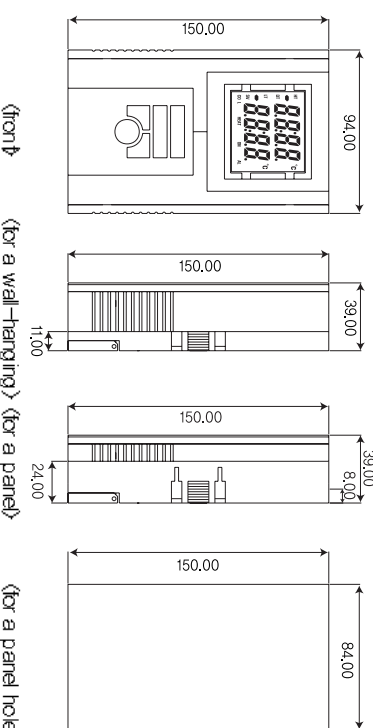

## 6 Temperature

### Setting for the temperature

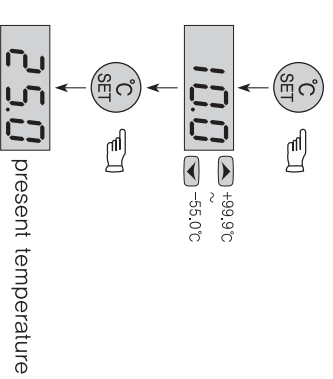

### Setting for temperature programs

press for more than 5sec.

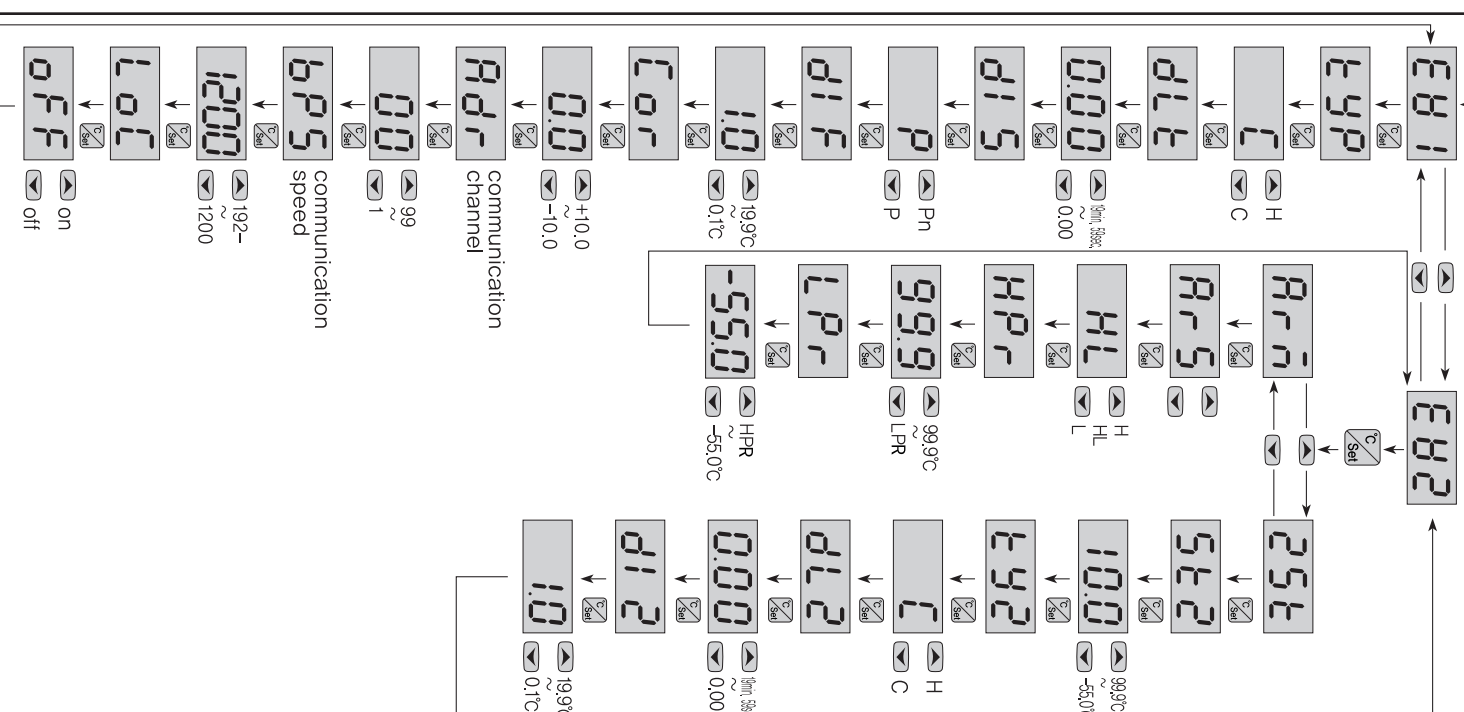

### Setting for the humidity

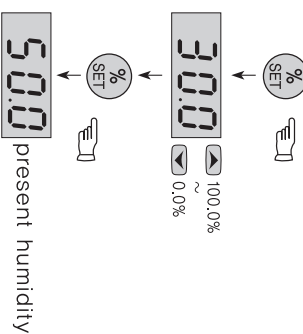

### Setting for humidity programs

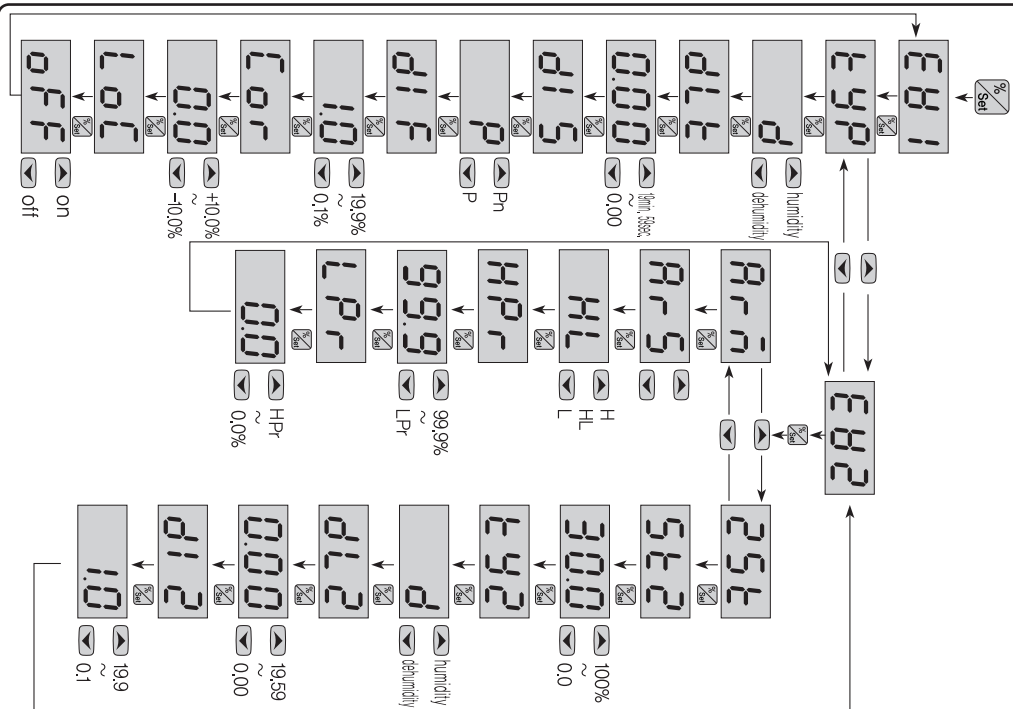

※To change it with program mode, press the **--key** for more than 5 second in the present temperature display mode.  
 ※The set of programming mode is terminated, if you press the **SET** key (parameter's set values) are saved after the display shows OK, Error or return to present temperature automatically after 3 second.

### 8 Detailed manual

- EYP** : temperature ; possible to select the cooling or heating, humidity ; possible to select the humidity or dehumidify.
- d i f** : Setting for temperature deviation
  - In the ON/OFF control, it needs at regular interval between ON and OFF.
  - By operating the ON/OFF control frequently, the relay or its output contact can be damaged quickly and it also occurs the hunting(oscillating, chattering) by virtue of external noise. You can make use of the temperature deviation in order to protect its relay or contact and so on.

「ex⇒」 The method of the temp. deviation when ON/OFF control  
 cooling / dehumidify      heating / humidity

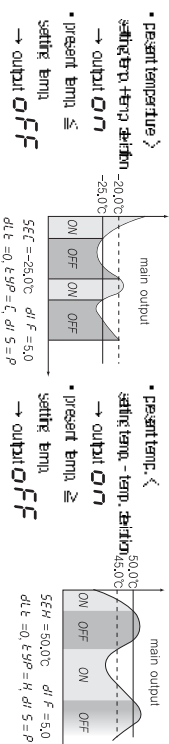

- d L E** : Delay time of the output
  - It is widely used as the followings
  - in case of operating the ON/OFF control very often, to protect the operation machinery when re-input of the power supply or momentary stoppage of power supply

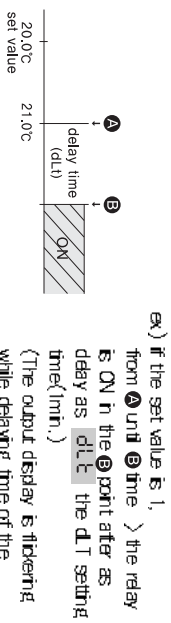

- C o r** : Correction of the present temperature.
  - It is used for the correction of a discrepancy between the display temperature and real temperature
  - real temp. : 10.0°C → **C o r** : 0.0 ⇒ -2.0 corrector display : 12.0°C
  - 10.0°C display(corrected present value)
- R d r** : Communication channel
  - To designate the channel while RS485 communication working
- b p s** : Communication speed(velocity)
  - 120 : 1200bps
  - 240 : 2400bps
  - 480 : 4800bps
  - 960 : 9600bps
  - 192 : 19200bps

- L o c** : The lock function : As a safety device, it is used in order not to change the set values except for the main user. ON - setting for the lock function, OFF - removal for the lock function
- R-r-n** : 25E auxiliary output → alarm function(impossible to set the 25E while this function working)
- 25E** : R-r-n auxiliary output → 2-stage function(impossible to set the R-r-n while this function working)
- H P r** : Setting function of the alarm temperature for the highest limit
  - It will be operated higher than HPr set value
- L P r** : Setting function of the alarm temperature for the lowest limit.
  - It will be operated lower than LPr set value
- R-r-5** : Selection of the alarm output style
  - H** : output is turn on - when a high or a low temperature is more than HPr set value
  - H L** : outputs are on - both more than HPr and less than LPr
  - L** : output is turn on - when a high or a low temperature is less than LPr set value.
- 5E2** : auxiliary output - refer to no.1
- EY2** : auxiliary output - refer to no.2
- d L 2** : auxiliary output - refer to no.3

### 9 Temp./humidity range when deliver

Display	Range	set values when deliver
%SET	temperature : -55.0~99.9°C	temperature : 19.0
EYP	humidity : 0.0~100.0%	humidity : 30.0
d L E	temperature : C / H	temperature : C
d i 5	humidity : d / H	humidity : d
d i F	0.00 ~ 19minute 59second	0.00
d i F	P / Pn	P
d i F	0.1 ~ 19.9	1.0
C o r	temperature : -15.0 ~ 15.0°C	humidity : -19.0 ~ 19.0%
L o c	on / OFF	OFF
R-r-n	selection of the alarm function	OFF
25E	2-stage setting function	
R-r-5	H / HL / L	HL
H P r	temperature : LPr ~ 99.9°C	temperature : 65.0°C
H P r	humidity : LPr ~ 100.0%	humidity : 95%
L P r	temperature : -55.0°C ~ HPr	temperature : -55.0°C
L P r	humidity : 0.0% ~ HPr	humidity : 0.0%
5E-2	temperature : -55.0 ~ 99.9°C	temperature : 19.0°C
E Y 2	humidity : 0.0 ~ 100.0%	humidity : 30.0%
E Y 2	temperature : C / H	temperature : C
d i 2	humidity : d / H	humidity : d
d i 2	0.00 ~ 19minute 59second	0.00
d i 2	0.1 ~ 19.9	1.0

### 10 Communication output

#### Interface

specification	in conformity, EA, RS485
maximum connection	32; however, analogue to set the Address from 01 ~ 99
The method of connection	two-wire half-duplex operation
synchronous system	asynchronous system
communication distance	within 1.2km
communication speed	1200/2400/4800/9600/19200bps(software to section)
Start bit	fixed 1bit
Stop bit	fixed 1bit
Parity bit	none
Data bit	fixed 8bit
Protocol	BCC

#### System

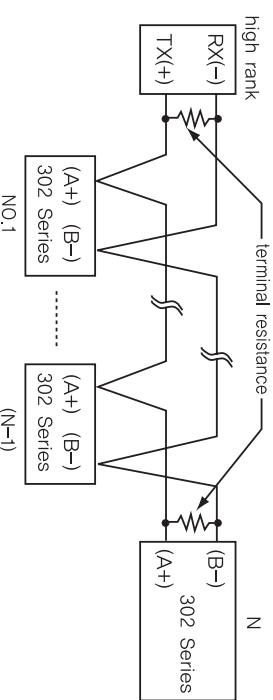

#### Definition between communication command and Block

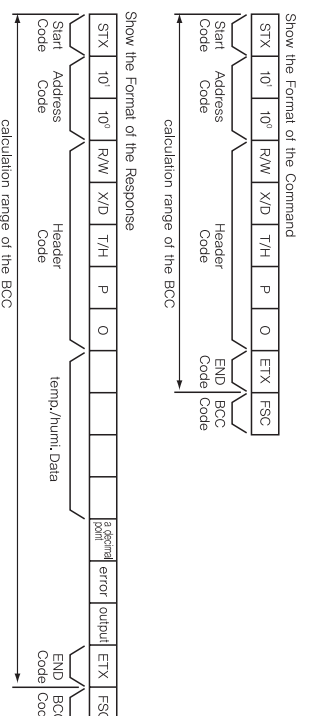

- Start Code**  
show the lead(head) of the Block  
ACK will be added in case of Response, STX→[02H]
- Address Code**  
A high rank system can discriminate the channel code number among FOX-302series  
It is available to set between 01 and 99(BCD ASC II)
- Header Code**

show the command name as an alphabetic letter  
 RX(reading demand) → R[52H], X[58H]  
 RD(reading response) → R[52H], D[44H]  
 WX(writing demand) → W[57H], X[58H]  
 WD(writing response) → W[57H], D[44H]  
 TP(temperature measuring value) → W[54H], P[50], O[30H]  
 HP(humidity measuring value) → H[48H], P[50], Q[30H]

- Composition of Data
- Data is displayed as "Hexadecimal"
- Decimal point → 0[30H] there is no "decimal point"  
1[31H] there is "decimal point"
- Error → 0[30H] there is no error  
1[31] open error of the sensor's cable  
2[32] short-circuited error of the sensor  
7 Output → 0[30H] TEMP/AL1 OUT ON  
HUM/AL2 OUT ON  
1[31H] TEMP/AL1 OUT ON  
HUM/AL2 OUT OFF  
2[32H] TEMP/AL1 OUT OFF  
HUM/AL2 OUT ON  
3[33H] TEMP/AL1 OUT OFF  
HUM/AL2 OUT OFF
- END Code
- show the end(close) of the Block. ETX→[03H]
- BCC (Block Check Character)

- show the XOR arithmetic and logic values from the start(STX) to the ETX
- the others : As of no response of the ACK
  - in case of not equivalent to the channel after receiving STX
  - in case of generating the Receive Buffer Overflow
  - in case of not equivalent to the communication's set values or baud rate treatment - in case of not response of the ACK
    - check the cable
    - check the communication's condition (set values)
    - if the main cause of the status is the noise, try to do communication practicing 3 times until recovering normally.
    - change the communication speed in case of bring about the communication's error frequently.

### 11 Error message

- If error is displayed while using the product:
  - E r** is displayed when the DATA memory element is damaged inside the product as it is affected by powerful noise from outside while in use. In this case, contact our company for customer service. While the controller is equipped with supplementary measures for outside noise, it cannot endure infinite noise. In case of the nose of 2KV or more flows in, inside of the product may be damaged.
  - The sensor has defect when **o - E** (Open Error) or **5 - E** (Short Error) is displayed. Please check the sensor.
- The product's specification can be changed without any notification to improve its quality. Please read and observe precautionary instructions during handling of the product.

※ Regarding the English language manual, please download it at our web-site.

■ H. Office : 56, Ballyongсандан 1-ro, Jangnan-eup, Gijang, Busan, Republic of Korea  
 ■ Factory : 56, Ballyongсандан 1-ro, Jangnan-eup, Gijang, Busan, Republic of Korea

■ TEL : +82-51-819-0426  
 ■ FAX : +82-51-819-4562  
 ■ e-mail : conotec@conotec.co.kr  
 ■ URL : www.conotec.co.kr

■ Main products & Development  
 - Digital Temperature controller  
 - Digital Humidity controller  
 - Digital timer

※ This device works proper operation with:  
 Surrounding Temp. : 0°C ~ 60°C  
 Surrounding Humil. : below 80%RH  
 Regular power : 220VAC ± 10% 50/60Hz