

OPERATING MANUAL NF-7HR Series



NF-7HR

1 Cautions for your safety

Please read the operating manual thoroughly before putting the device into operation

※ Product specifications and accessories may be changed at any time based on improvements and other reasons.

CAUTION

1. Pls use this item after installing the duplex safety device in which is applied at dangerous factors such as serious human injury or serious damages of property & important machine because this item is not designed as a safety device.
2. Do not check or repair when it is power on
3. Pls check the terminal number before connecting power supply.
4. Do not disassemble or open, remodel, repair without any permission.

SAFETY

1. Please read the operating manual through completely before putting the device into operation.
2. We will not assume any responsibility for damage to assets or persons caused by improper handling or failure to observe the safety instructions or hazard warnings.
3. For safety and licensing reason, unauthorized conversion and/or modification of the device is not permitted.
4. Do not exceed the maximum permissible current – in case of higher loads, use a contactor of adequate power. Make sure that the supplied voltage matches the values specified for the instrument.
5. The device must be adequately protected from water and dust as per the application and must be accessible via the use of appropriate tools.
6. The device must not be exposed to extreme temperature, sunlight, strong vibrations or high levels of humidity.
7. Operation or installation in not permitted under unfavorable ambient conditions such as wetness or excessive induction loads or solenoid and dust, combustible gases, vapors or solvents, especially high-frequency noise.
8. Avoid operation or installation close to high-frequency fields such as welding devices, sewing machines, wireless transmitter, radio systems, SCR controller, etc
9. Do not install the sensor cable nearby signal cable, power cable, load cable.
10. Please use the shield cable when the sensor cable's lengthen, however do not make it too much longer.
11. Please use the sensor cable without any cutting or flaw, blemish.
12. The device is not a toy and should be kept away from children.
13. installation work must only be carried out by suitably qualified personnel who are familiar with the hazards involved and with the relevant regulations.
14. you shouldn't tinker with anything or the product may not be opened or disassembled unless you know what you're doing.
Please ask us about this questioning.

DANGER

Caution, Danger of electric shock

- Electric shock – Do not touch AC board during on power because of electric shock.
- Please intercept the input power surely when turn on power because of electric shock.

2 Model

| MODEL | Main output | Input | Range | Power supply | Size | Features |
|----------|-------------|----------|----------|------------------------|---------------------|-----------------|
| NF-7HR-1 | Contact | HCPV-220 | 10 ~ 95% | 100~240 VAC 50/60Hz | 72(W) * 72(H) | • Dehumi./humi. |
| NF-7HS | SSR(DC+24V) | | | | | |

3 Controls and indicators

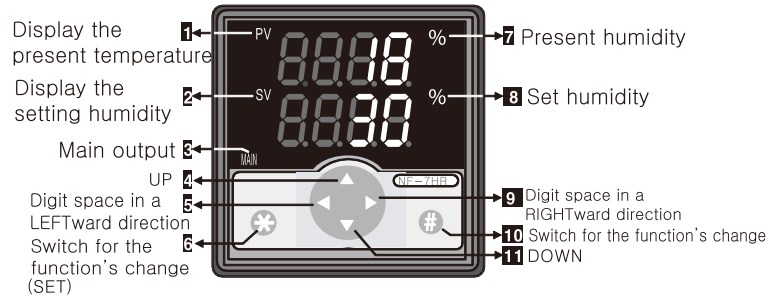

◆ **User's mode changing(setting humidity)**
Changing the setting humidity for main output.
By once pressing the key * or #, displays *SEt* on FND at upper side, and displays the set value on FND at lowerside.
The set value should be UP or DOWN with ▲ or ▼ key, the space for the set value should be moved to left and right with ◀ or ▶ key.

◆ **Installer's mode function setting**
By pressing * or # key for 5 seconds, shall be displayed the name of menu on FND at upper side and the set value on FND at lowerside.
Setting value with the key ▲ or ▼ to increase or decrease, and with the key ◀ or ▶ to change the setting value by moving the space from side to side.

4 Connection

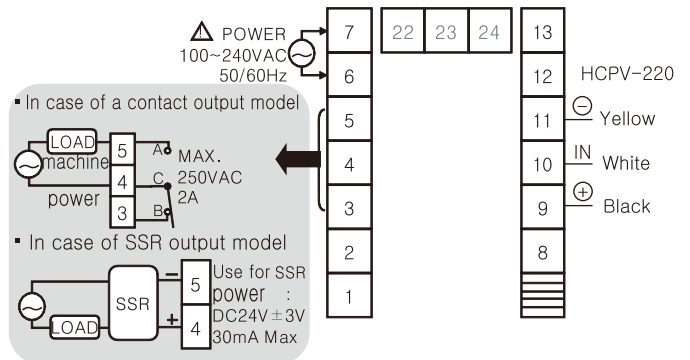

⚠ *Relay connection capacity is less than 250VAC 2A.
Please note that load exceeds the capacity of the contacts using can cause the contact welding, connection failure, damage to the relay, etc..

5 Dimension (unit : mm)

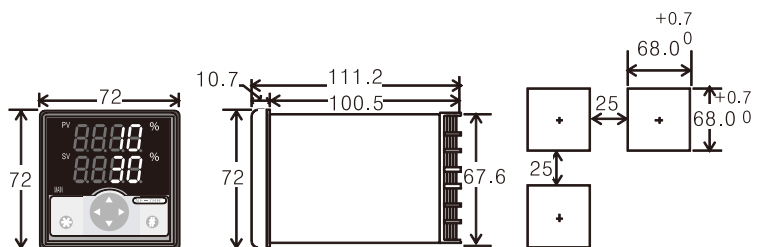

6 Change order for the setting value

Setting the humidity for main & auxiliary output

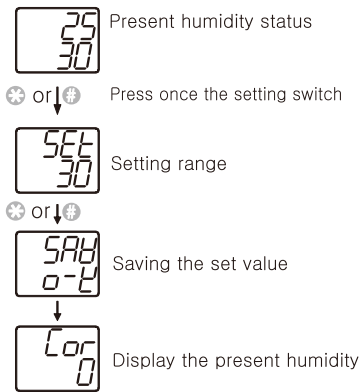

Setting the main output & communication

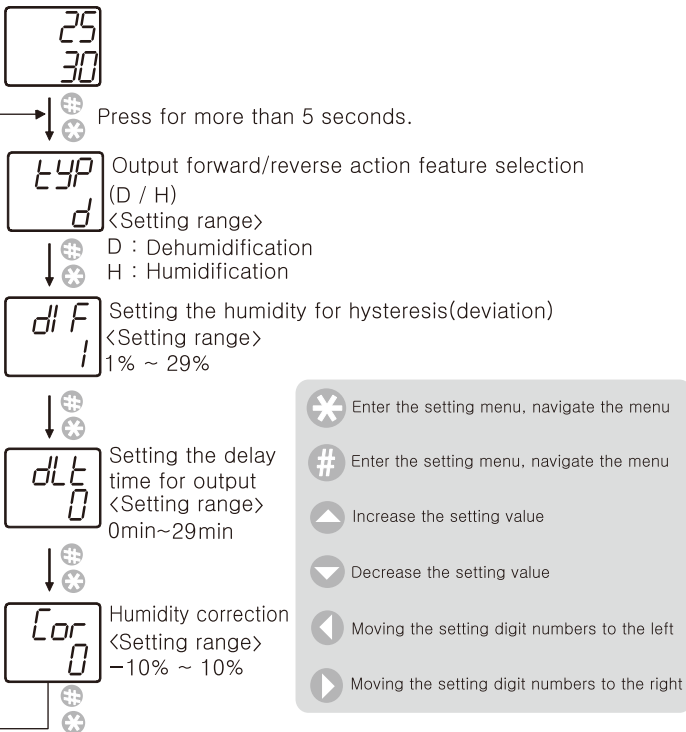

7 Detailed description

- SET** : Main output setting available
- LTP** : Main output function setting available
d = when used for dehumidification
H = when used for humidification

Do not convert humidity/dehumidity while operation.
 Make sure of selection only one way of humidity/dehumidity,
 output simultaneously is not available.

- dIF** : Deviation humidity setting available

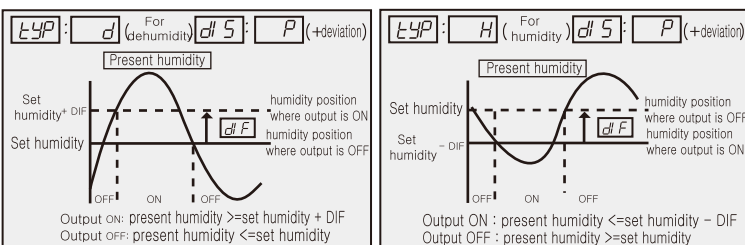

- dLE** : Setting output delay time

- In case of operating the ON/OFF control very often.
 - To protect the operation machinery when re-input of the power supply or momentary stoppage of power supply
- e) Set humidity : 51%RH, type : dehumidify
 Deviation humidity : 1%RH, delay time : 1 min

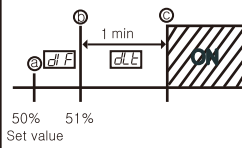

- Cor** : Correction of the present temp.

- The product itself has no problem, but the correction functioned for that if humidity differs between an error occurs in the input sensor from outside and basic humidity.

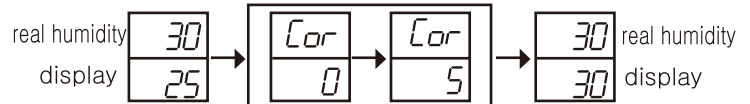

8 How to diagnose a breakdown

- Indicating ERROR on using items
- This **Err** is the damage of memory data for various of inner-DATA due to be got nosied strongly from outside while using this items. Please request us A/S by return. Although our controller is designed as the complementary measures regarding these noise from outside, it is not endurable against these noise with endlessly.
- If noise(2KV) disordering become an inflow, the inner-part will be damaged.
- When shows these letter **o-E** (open error), **S-E** (short error) error in sensor. Please check sensor.

* Above product's information can be changed to improve its quality without any notification. When using this product, please observe the information of caution & warning due to give rise to disordering.

* Regarding the English-language manual, please download it at our homepage.

■ H. Office : 56, Ballyongsandan 1-ro, Jangan-eup, Gijang, Busan, Republic of Korea
 ■ Factory : 56, Ballyongsandan 1-ro, Jangan-eup, Gijang, Busan, Republic of Korea

■ TEL : +82-51-819-0426
 ■ FAX : +82-51-819-4562
 ■ e-mail : conotec@conotec.co.kr
 ■ URL : www.conotec.co.kr

■ Main products & developments
 - Digital temp./humi. controller.
 - Digital timer, Current/Volt meter
 - Development of other product